

R553W, R553W-2, R551W INSULATIONS FOR DISTRIBUTION MANIFOLDS

R553W

Cross-linked polyethylene closed cell foam insulation set, with:

- 2 insulations for R554D + R259D ball valve or for R269T multifunction valves.
- Insulations for end caps.



Product code	Insulations...	End caps for manifolds...
R553WY002	...for R554D + R259D ball valve	...R553F (1") ...R53MT+R53VT (1")
R553WY004	...for R554D + R259D ball valve	...R553D (1") ...R53ST+R53VT (1")
R553WY006	...for R554D + R259D ball valve	...R553F (1 1/4") ...R53MT+R53VT (1 1/4")
R553WY008	...for R554D + R259D ball valve	...R553D (1 1/4") ...R53ST+R53VT (1 1/4")
R553WY012	...for R269T multifunction valves	...R553F (1") ...R53MT+R53VT (1")
R553WY014	...for R269T multifunction valves	...R553D (1") ...R53ST+R53VT (1")
R553WY016	...for R269T multifunction valves	...R553F (1 1/4") ...R53MT+R53VT (1 1/4")
R553WY018	...for R269T multifunction valves	...R553D (1 1/4") ...R53ST+R53VT (1 1/4")

R553W-2

Cross-linked polyethylene closed cell foam insulation set. For R553F, R553D or modular manifolds (delivery and return), with maximum 12 connections.

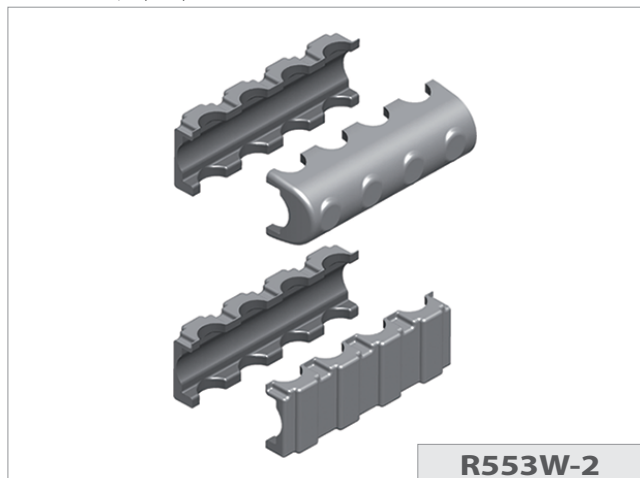

Product code	Max. number of connections	For manifolds...
R553WY001	12	...R553F (1")
R553WY003	12	...R553D (1")
R553WY005	12	...R553F (1 1/4") ...R53MM, R53MT, R53VM, R53VT (1" and 1 1/4")
R553WY007	12	...R553D (1 1/4") ...R53SM, R53ST, R53VM, R53VT (1" and 1 1/4")

R551W













Insulation shell in polystyrene foam, for R551 manifolds.

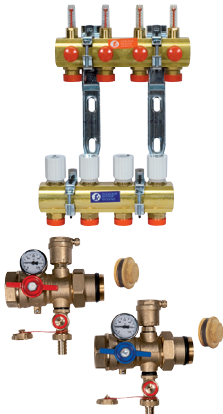

Product code	Max. number of connections	For manifolds...
R551WY005	12	...R551 (3/4") distance 50 mm
R551WY006	12	...R551 (1 1/4") distance 70 mm
R551WY007	6	...R551 (1 1/2") distance 100 mm
R551WY008	6	...R551 (2") distance 100 mm
R551WY009	6	...R551 (1") distance 50 mm

R553W, R553W-2, R551W INSULATIONS FOR DISTRIBUTION MANIFOLDS

Manifolds and groups for manifolds

R535M 	R535T 	R53MM 	R53MT 
R53VM 	R53VT 	R553D 	R553F 
R553DK 	R553FK 	R554D 	R269T 
		R259D 	

Example of installation

Insulations R553W + R553W-2 + R553F manifold with R554D group + R259D ball valve

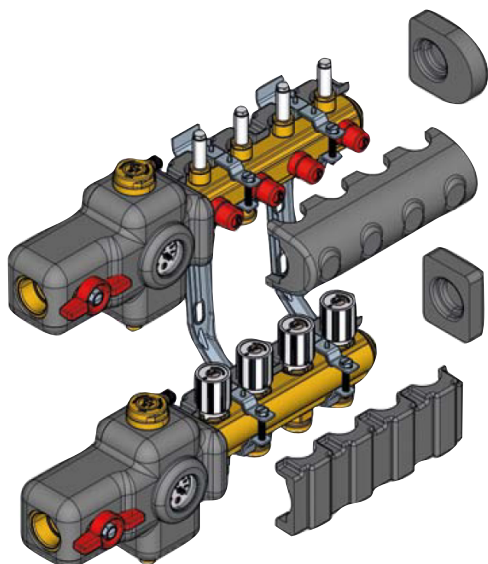

R551W insulation + R551 manifold

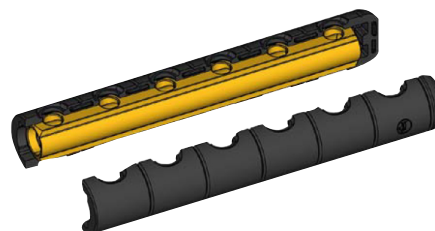

Additional information

For additional information please check the Giacomini website at the following address: www.giacomini.com

☎ +39 0322 923 372

☎ +39 0322 923 255

✉ consulenza.prodotti@giacomini.com

This pamphlet is merely for information purposes. Giacomini S.p.A. retains the right to make modifications for technical or commercial reasons, without prior notice, to the items described in this pamphlet. The information described in this technical pamphlet does not exempt the user from following carefully the existing regulations and norms on good workmanship.

Giacomini S.p.A. Via per Alzo 39, I-28017 San Maurizio d'Opaglio (NO) Italy