

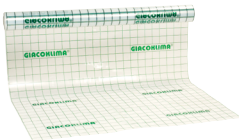





K389W

Description

Thanks to the special shape of the pipe housing, the K389W pipe fixing track allows for an exceptionally quick and safe laying of radiant system circuits, both on large floor surfaces and on walls. The radiant system structure is as follows:

	K369A
	Wall insulation for radiant systems
	R984
	Cover sheet, in polythene
	K389W
	Pipe fixing track
	R996T
	PEX pipe with BAO
	R549P
	Bend support

Versions and product codes

Product code	Size [mm]	Bar lenght [m]
K389WY001	Ø 12÷22	1

Furthermore, holes are provided for screws and/or dowels, with a centre distance of 100 mm, for fixing the system to floors or walls.

Main characteristics

The K389W pipe fixing track can house pipes with an external diameter of 12÷22 mm, for the construction of heating coils with multiple pitches of 50 or 100 mm.

Ø of pipes to be housed in small pipe-holder track (A)	Ø of pipes to be housed in large pipe-holder track (B)
12÷18 mm	16÷22,2 mm Oval pipes 17x24 mm

Pipes Ø [mm]	Pitch [mm]
12÷15	100
16÷18	50
19,1÷22,2	100
Tubi ovali 17 x 24	100

The pipe fixing track is equipped with a solid quick coupling bayonet connection system between individual elements, so that the necessary support can be provided for radiant system circuits across the entire surface in question.

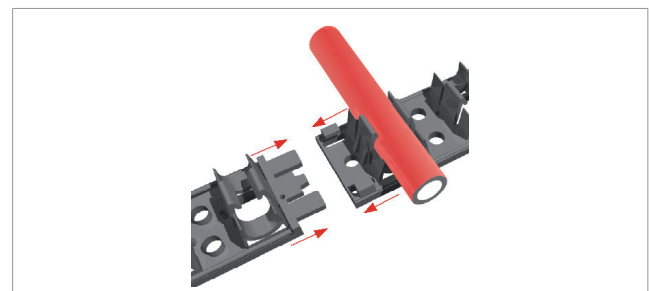

Wall installation description

The circuits for the radiant wall system (Fig. 1) can be derived directly from the floor system's distribution manifold, which must be designed, built, tested, and operated in accordance with the requirements of EN 1264.

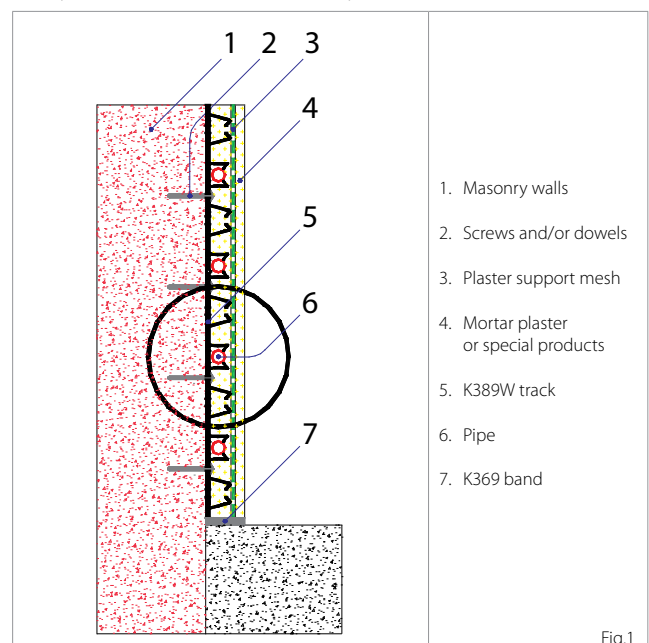

Fig.1

Furthermore, as a consequence of the reduced thermal resistance determined by the layer of plaster, the radiant wall system circuits can be



laid with a less dense pitch than that used for the radiant floor system, and delivery temperature can be limited to between 40 °C and 45 °C, to avoid the localization of the thermal stresses on the layer of plaster. If the radiant wall system is to be covered with ceramic materials, however, the thermal output can be considered equivalent to that of a radiant floor system, constructed with the same pitch installation.

To facilitate air ventilation from radiant wall system circuits, the R414D valve can be coupled to a R66A manual air vent on installation. This system can be housed in the dedicated R508M casing and can be adjusted with a thermostatic head.

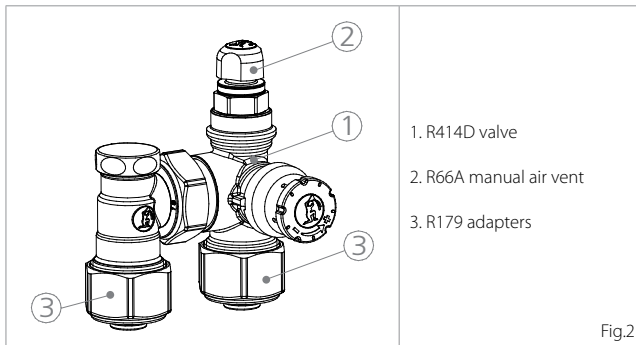

The adjustment of ambient temperature, carried out using the thermostatic head, allows for a reduction in the use of electrical equipment in bathrooms and other environments in which there is often a significant presence of water vapour and condensation.

The installation of the radiant wall system, using the K389 pipe fixing track, must take place on a surface that is suitably insulated to the outside (where necessary) and adequately prepared for plastering. Using the range of Giacomini RP/RM mechanical pressure connectors, it is also possible to connect different radiant system circuits using the reverse return method.

The radiant system circuits (Fig. 3) must be laid up to a maximum height of 2÷2,5 m, limiting the length of the individual rings depending on the losses of pressure generated by the piping used. Any connection of electrical equipment on the wall must be protected by appropriate casing, and positioned at a suitable distance from the radiant system circuits.

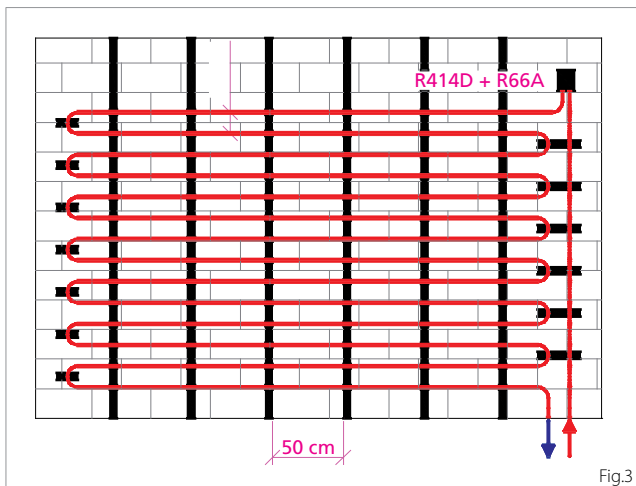

- Lay the K389 wall insulation along the entire profile of the radiant wall system, where the heated surface provides for significant thermal expansion.
- Attach the K389W pipe fixing track to the wall using the holes provided for screws and/or dowels. The distance between two successive tracks should be no more than 50 cm.
- Lay the pipe which comes from the delivery manifold on the vertical plane, using the R594P bend, and connect it to the R414D + R66A group, securing with the lengths of the K389W pipe fixing track.

- On its exit from the R414D + R66A group, lay out a coil at fixed intervals, anchoring it to the K389W pipe fixing track. In correspondence with the bends, it is good practice to ensure that the pipe is accompanied in a similar manner to that indicated for the stretch from the delivery manifold.
- Restore the circuit to the horizontal plane, using the R594P bend, and connect it to the return manifold. If the lengths of tubing between the distribution manifolds and the radiant wall system reach a significant length, ensure that these are isolated.
- Proceed to flushing and filling the system, making sure that any air bubbles formed during these interventions have been fully discharged, and carry out pressure testing, even during the plastering of the radiant wall.
- The system must only be switched on for the first time once the plaster layers are completely dry.

For the coating of the radiant wall system, mortar plaster can be used, with gypsum or cement-based binders, or special products specifically recommended by the manufacturer. Note that gypsum and cement are substances that can trigger corrosion when they are placed in permanent contact with copper or its alloys, such as brass.

The field of application and the procedure for preparing the bed and laying the plaster layer must in any case comply with manufacturer instructions and good practice standards, which must be agreed before work commences, to ensure an effective and safe result, both in terms of structure and of thermal efficiency.

The layer of plaster that covers the radiant wall system must be reinforced with an adequate plaster support net, to improve consistency texture and shape. The type of netting must be selected by the installer depending on the intended area of use and on the characteristics stated by the manufacturer. Maintaining a light tension, the reinforcing mesh must be applied on the laid plaster/stucco, until it reaches the depth of the radiant wall system. The plaster support mesh must cover the entire radiant surface, protruding with a reasonable safety margin, and must overlap any adjacent elements.

The coating over the reinforcing net may consist of the completed layer of plaster, or in a second layer, applied after the first has set sufficiently. In all cases, the thickness of the covering over the radiant wall system must not be less than 10 mm.

Dimensions



Product specifications

K389W

Pipe fixing track with quick and safe bayonet connection for radiant system circuits. Can house pipes with diameters from 12 to 22 mm. Multiple pitches of 50 or 100 mm. Quick coupling bayonet connection system between individual elements, suitable for fixing to floors or walls.

Additional information

For additional information please check the website www.giacomini.com or contact the technical service: ☎ +39 0322 923372 📠 +39 0322 923255 ✉ consulenza.prodotti@giacomini.com
 This pamphlet is merely for information purposes. Giacomini S.p.A. retains the right to make modifications for technical or commercial reasons, without prior notice, to the items described in this pamphlet. The information described in this technical pamphlet does not exempt the user from following carefully the existing regulations and norms on good workmanship.
 Giacomini S.p.A. Via per Alzo, 39 - 28017 San Maurizio d'Opaglio (NO) Italy